

SERIE 6000



Características

- Cuerpo totalmente en bronce niquelado
- Resortes de acero inox. y juntas de Nitrilo
- Presión de servicio 20 bars
- Consumo a 6 bars:
A-Standard: 20 m3/h.
B-Escudo de Protección: 37 m3/h.
C -Amplificador de Caudal: 20 m3/h.
D -Limitador de Caudal: 15 m3/h.
- Sensible mecanismo para controlar el caudal

Curva de Presión / Caudal

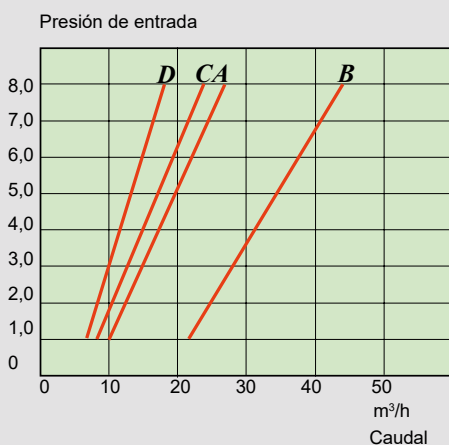

RACORD 6081

SERIE 4000 6082

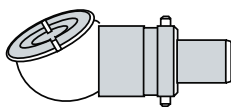

INFLADOR BOLITA

160 mm 6083

200 mm 6084

COMODÍN 6085



INFLADOR PIE DUAL

Descripción

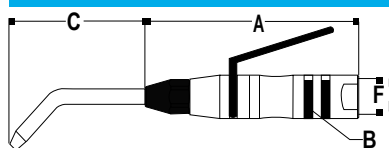

Standard

F	Código	A	B	C
1/4 BSP	6001 (aire)	86.00	19.00	100
1/4 BSP	6010 (agua)	86.00	19.00	100

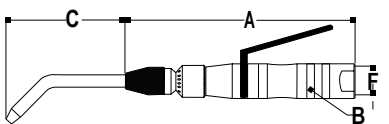

Pantalla de protección

1/4 BSP	6002	97.00	19.00	100
---------	-------------	-------	-------	-----



Amplificador de Caudal

1/4 BSP	6003	68.00	19.00	57
---------	-------------	-------	-------	----

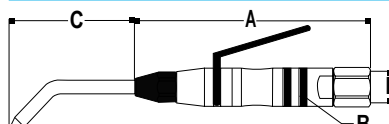

Limitador de Caudal

1/4 BSP	6009 (2 Bar)	102.00	19.00	100
1/4 BSP	6009 (3,5 Bar)	102.00	19.00	100

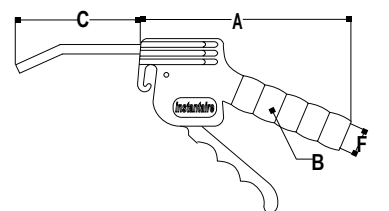

Pistola de Resina Acetal

1/4 BSP	6011	140.00	22.00	100
1/4 BSP	6012	140.00	22.00	200

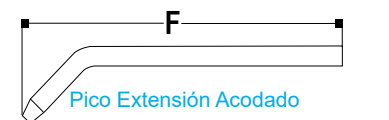

Pico Extensión Acodado

100 mm	6006
200 mm	6012

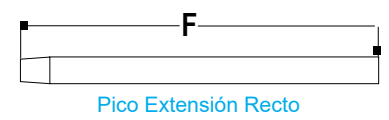

Pico Extensión Recto

100 mm	6004
200 mm	6005

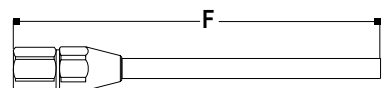

Pico Flexible

300 mm	6008
500 mm	6013



Descripción	Rosca	Diámetro	Estiramiento			
			2.50	5.00	7.50	12.00

KIT DE POLIAMIDA
Con Acoplamiento Serie 4000 y Pistola 6001

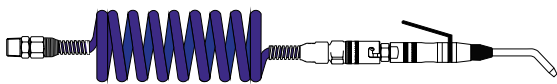

1/4 BSP	1/4"	6018	6019	6020	6021
1/4 BSP	5/16"	6014	6015	6016	6021
1/4 BSP	3/8"	6022	6023	6024	6025

KIT DE POLIAMIDA
Con Acoplamiento Serie 8000 y Pistola 6001

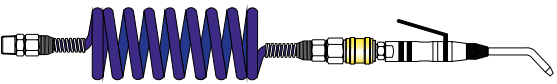

1/4 BSP	1/4"	6032	6033	6034	6035
1/4 BSP	5/16"	6036	6037	6038	6039
1/4 BSP	3/8"	6040	6041	6042	6043

KIT DE POLIAMIDA
Con Acoplamiento Serie 8000 y Pistola 6011

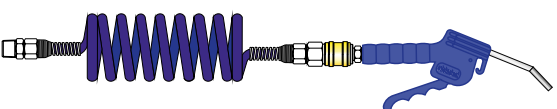

1/4 BSP	1/4"	6044	6045	6046	6047
1/4 BSP	5/16"	6048	6049	6050	6051
1/4 BSP	3/8"	6052	6053	6054	6055

Descripción	Rosca	Diámetro	Estiramiento		
			3.00	6.00	9.00

KIT DE POLIESTER
Con Acoplamiento Serie 8000 y Pistola 6001



1/4 BSP	1/4"	6026	6027	6028
1/4 BSP	5/16"	6029	6030	6031

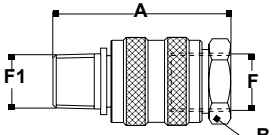

Descripción	F	F1	Código	A	B
 Regulación de Caudal	1/8 BSP	1/8 BSP	6101	38.00	5/8"
	1/4 BSP	1/4 BSP	6102	43.00	3/4"
	3/8 BSP	3/8 BSP	6103	50.00	7/8"

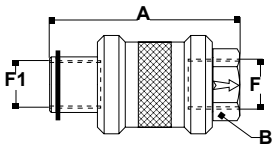
 Válvula Colizante	1/8 BSP	1/8 BSP	6111	44.50	5/8"
	1/4 BSP	1/4 BSP	6112	58.00	3/4"
	3/8 BSP	3/8 BSP	6113	58.00	7/8"
	1/2 BSP	1/2 BSP	6114	70.00	1"

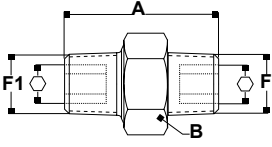
Descripción	F	Hex	Código	A	B
 Unión Doble R. Macho	1/8 BSP	5,00	6121	28.00	5/8"
	1/4 BSP	6,00	6122	34.00	3/4"
	3/8 BSP	8,00	6123	40.00	7/8"
	1/2 BSP	12,00	6124	49.00	1"1/4

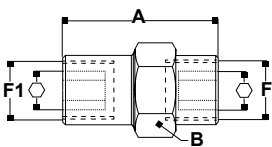
 Unión Doble R. Hembra	1/8 BSP	6,00	6131	28.00	9/16"
	1/4 BSP	8,00	6132	37.00	7/8"
	3/8 BSP	10,00	6133	46.00	1"
	1/2 BSP	12,00	6134	51.00	1"1/4

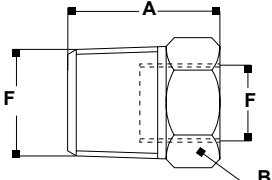
Descripción	F	F1	Código	A	B
 Reducción macho-hembra	1/4 BSPT	1/8 BSP	6202	15.00	9/16"
	3/8 BSPT	1/8 BSP	6205	15.00	11/16"
	3/8 BSPT	1/4 BSP	6203	15.00	11/16"
	1/2 BSPT	1/8 BSP	6206	17.00	7/8"
	1/2 BSPT	1/4 BSP	6207	17.00	7/8"
	1/2 BSPT	3/8 BSP	6204	17.00	7/8"
	3/4 BSPT	1/4 BSP	6208	23.00	1"1/8
	3/4 BSPT	1/2 BSP	6209	23.00	1"1/8
	1" BSPT	1/2 BSP	6210	37.00	1"3/8
	1" BSPT	3/4 BSP	6211	37.00	1"3/8

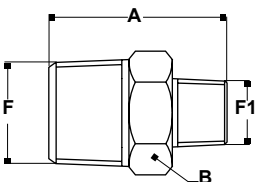
Descripción	F	F1	Código	A	B
 Reducción macho-macho	1/4 BSPT	1/8 BSPT	6315	23.00	9/16"
	3/8 BSPT	1/8 BSPT	6311	23.00	11/16"
	3/8 BSPT	1/4 BSPT	6316	23.00	11/16"
	1/2 BSPT	1/8 BSPT	6312	25.00	7/8"
	1/2 BSPT	1/4 BSPT	6313	27.00	7/8"
	1/2 BSPT	3/8 BSPT	6317	28.00	7/8"
	3/4 BSPT	1/4 BSPT	6314	32.00	1"1/8
	3/4 BSPT	1/2 BSPT	6318	35.00	1"1/8
	1" BSPT	1/2 BSPT	6319	53.00	1"3/8
	1" BSPT	3/4 BSPT	6320	56.00	1"3/8

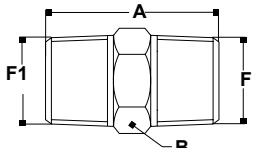
 Enteroscas	1/8 BSPT	1/8 BSPT	6321	23.00	1/2"
	1/4 BSPT	1/4 BSPT	6322	27.00	9/16"
	3/8 BSPT	3/8 BSPT	6323	32.00	11/16"
	1/2 BSPT	1/2 BSPT	6324	42.00	7/8"
	3/4 BSPT	3/4 BSPT	6325	50.00	1"1/8
	1" BSPT	1" BSPT	6326	62.00	1"3/8

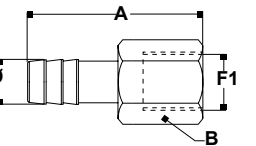
Descripción	F	Ø	Código	A	B
 Racord Fijo con Rosca Hembra	1/8 BSP	1/4"	6401	36.00	1/2"
	1/8 BSP	5/16"	6402	36.00	1/2"
	1/8 BSP	3/8"	6403	36.00	1/2"
	1/4 BSP	1/4"	6404	38.00	5/8"
	1/4 BSP	5/16"	6405	38.00	5/8"
	1/4 BSP	3/8"	6406	38.00	5/8"
	1/4 BSP	1/2"	6407	38.00	5/8"
	3/8 BSP	5/16"	6408	40.00	13/16"
	3/8 BSP	3/8"	6409	40.00	13/16"
	3/8 BSP	1/2"	6410	40.00	13/16"
	1/2 BSP	3/8"	6411	42.00	1"
	1/2 BSP	1/2"	6412	42.00	1"
	1/2 BSP	3/4"	6413	42.00	1"

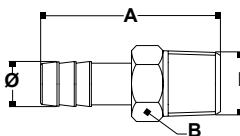
Descripción	F	Ø	Código	A	B
 <p>Racord Fijo con Rosca Macho</p>	1/8 BSPT	1/4"	6541	36.00	7/16"
	1/8 BSPT	5/16"	6542	36.00	7/16"
	1/8 BSPT	3/8"	6543	36.00	7/16"
	1/4 BSPT	1/4"	6546	37.00	9/16"
	1/4 BSPT	5/16"	6547	37.00	9/16"
	1/4 BSPT	3/8"	6548	37.00	9/16"
	1/4 BSPT	1/2"	6549	37.00	9/16"
	3/8 BSPT	5/16"	6581	41.00	11/16"
	3/8 BSPT	3/8"	6582	41.00	11/16"
	3/8 BSPT	1/2"	6583	41.00	11/16"
	1/2 BSPT	3/8"	6594	44.00	7/8"
	1/2 BSPT	1/2"	6595	44.00	7/8"
	1/2 BSPT	3/4"	6596	44.00	7/8"
	3/4 BSPT	3/4"	6597	54.00	1"1/8
	1" BSPT	3/4"	6598	59.00	1"5/8
	1" BSPT	1"	6599	64.00	1"5/8

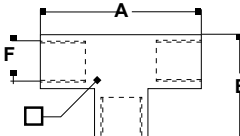
Descripción	F	Ø	Código	A	B
 <p>Conector "T" con Rosca Hembra</p>	1/8 BSP	13.00	6765	27.00	20.00
	1/4 BSP	16.00	6766	31.00	24.00
	3/8 BSP	20.00	6767	44.00	33.00
	1/2 BSP	25.00	6768	44.00	35.00

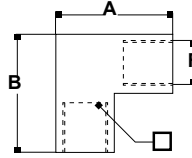
Descripción	F	Ø	Código	A	B
 <p>Codo con Rosca Hembra</p>	1/8 BSP	13.00	6785	20.00	20.00
	1/4 BSP	16.00	6786	24.00	24.00
	3/8 BSP	20.00	6787	33.00	33.00
	1/2 BSP	25.00	6788	35.00	35.00

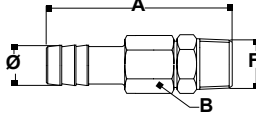
Descripción	F	Ø	Código	A	B
 <p>Conexión Giratoria Racord - Rosca Macho</p>	1/8 BSP	1/4"	6826	53.00	9/16"
	1/4 BSP	5/16"	6827	53.00	5/8"
	3/8 BSP	3/8"	6828	63.00	11/16"
	1/2 BSP	1/2"	6829	60.00	7/8"

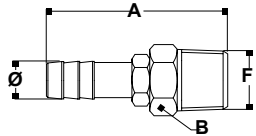
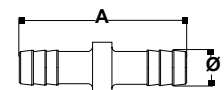
Descripción	F	Ø	Código	A	B
 <p>Racord Giratorio</p>	1/4 BSPT	1/4"	6616	41.00	9/16"
	1/4 BSPT	5/16"	6617	41.00	9/16"
	1/4 BSPT	3/8"	6618	41.00	9/16"
		1/4"	6721	45.00	
 <p>Racord Doble</p>		5/16"	6722	45.00	
		3/8"	6723	46.00	
		1/2"	6724	53.00	

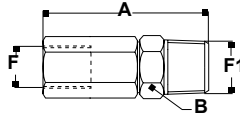
Descripción	F	F1	Código	A	B
 <p>Conexión Giratoria Hembra - Macho</p>	1/8 BSP	1/8 BSPT	6831	40.00	9/16"
	1/4 BSP	1/8 BSPT	6831B	40.00	5/8"
	1/4 BSP	1/4 BSPT	6832	43.00	5/8"
	1/4 BSP	3/8 BSPT	6832B	43.00	5/8"
	3/8 BSP	3/8 BSPT	6833	49.00	3/4"

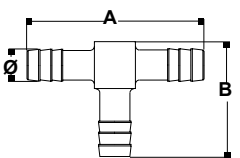
Descripción	F	Ø	Código	A	B
 <p>Racord "T"</p>		1/4"	6734	51.00	32.00
		5/16"	6735	54.00	34.00
		3/8"	6736	57.00	36.00
		1/2"	6737	60.00	39.00

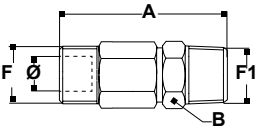
Descripción	F	F1	Código	A	Ø
 <p>Conexión Giratoria Macho - Macho</p>	1/8 BSP	1/8 BSPT	6836	37.00	1/4"
	1/8 BSP	1/4 BSPT	6840	36.00	5/16"
	1/4 BSP	1/8 BSPT	6835	39.00	1/4"
	1/4 BSP	1/4 BSPT	6837	40.00	5/16"
	1/4 BSP	3/8 BSPT	6841	42.00	3/8"
	1/4 BSP	1/2 BSPT	6843	42.00	1/2"
	3/8 BSP	3/8 BSPT	6838	46.00	3/8"
	3/8 BSP	1/2 BSPT	6844	47.00	1/2"
	1/2 BSP	3/8 BSPT	6842	53.00	3/8"
	1/2 BSP	1/2 BSPT	6839	60.00	1/2"

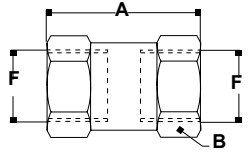
Descripción	F	Ø	Código	A	B
 <p>Cupla</p>	1/8 BSP		6751	21.00	1/2"
	1/4 BSP		6752	25.00	9/16"
	3/8 BSP		6753	30.00	13/16"
	1/2 BSP		6754	35.00	1"
	3/4 BSP		6755	40.00	1"1/4
	1" BSP		6756	48.00	1"5/8

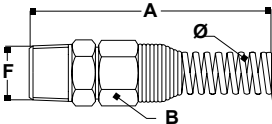
Descripción	F	Ø	Código	A	B
 <p>Conexión Standard para Tubo Plástico</p>	1/8 BSP	1/4"	6901	120	1/2"
	1/4 BSP	1/4"	6902	120	5/8"
	1/8 BSP	5/16"	6903	150	5/8"
	1/4 BSP	5/16"	6904	150	5/8"
	1/4 BSP	3/8"	6905	160	3/4"
	3/8 BSP	3/8"	6909	160	3/4"
	1/2 BSP	3/8"	6910	165	7/8"
	1/4 BSP	1/2"	6906	190	7/8"
	3/8 BSP	1/2"	6907	190	7/8"
	1/2 BSP	1/2"	6908	190	7/8"

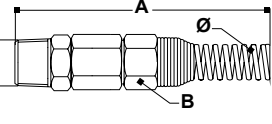
 <p>Conexión Giratoria para Tubo Plástico</p>	1/8 BSPT	1/4"	6911	130	1/2"
	1/4 BSPT	1/4"	6915	130	5/8"
	1/8 BSPT	5/16"	6916	160	5/8"
	1/4 BSPT	5/16"	6912	160	5/8"
	1/4 BSPT	3/8"	6917	170	3/4"
	3/8 BSPT	3/8"	6913	170	3/4"
	1/2 BSPT	3/8"	6918	175	7/8"
	1/4 BSPT	1/2"	6919	200	7/8"
	3/8 BSPT	1/2"	6920	200	7/8"
	1/2 BSPT	1/2"	6914	200	7/8"

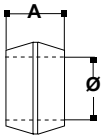
 <p>Conos de Ajuste</p>	1/4"	6921	6,00
	5/16"	6922	6,50
	3/8"	6923	6,50
	1/2"	6924	8,50
	4 mm	6925	5,00
	6 mm	6926	6,00
	8 mm	6927	6,50
	10 mm	6928	7,00
12 mm	6929	8,50	

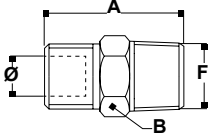
 <p>Conector de Ajuste con Rosca Gas</p>	1/8 BSPT	1/4"	6931	21,00	7/16"
	1/4 BSPT	1/4"	6932	21,00	9/16"
	1/8 BSPT	5/16"	6933	21,00	9/16"
	1/4 BSPT	5/16"	6934	23,00	9/16"
	1/4 BSPT	3/8"	6935	27,00	11/16"
	3/8 BSPT	3/8"	6939	27,00	11/16"
	1/2 BSPT	3/8"	6940	27,00	3/4"
	1/4 BSPT	1/2"	6936	27,00	3/4"
3/8 BSPT	1/2"	6937	27,00	3/4"	
1/2 BSPT	1/2"	6938	29,00	7/8"	

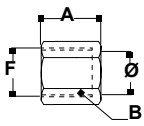
Descripción	F	Ø	Código	A	B
 <p>Tuerca de Ajuste</p>	1/8 BSP	1/4"	6941	12.00	1/2"
	1/4 BSP	5/16"	6942	14.00	9/16"
	3/8 BSP	3/8"	6943	15.00	3/4"
	1/2 BSP	1/2"	6944	18.00	1"

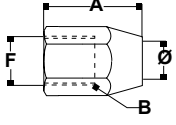
 <p>Tuerca de Ajuste Cónica</p>	1/8 BSP	1/4"	6946	18.00	1/2"
	1/4 BSP	5/16"	6946	21.00	9/16"
	3/8 BSP	3/8"	6948	23.00	3/4"
	1/2 BSP	1/2"	6949	24.00	7/8"

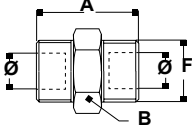
 <p>Unión para Tubos Plásticos</p>	1/8 BSP	1/4"	6951	21.00	1/2"
	1/4 BSP	5/16"	6952	22.00	5/8"
	3/8 BSP	3/8"	6953	29.00	3/4"
	1/2 BSP	1/2"	6954	29.00	7/8"

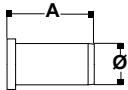
 <p>Refuerzo para Tubo Plástico</p>	4,60	1/4"	6956	12.00
	6,00	5/16"	6957	13.00
	7,50	3/8"	6958	14.00
	8,50	1/2"	6959	15.00

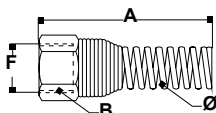
 <p>Tuerca de Ajuste con Protección</p>	1/8 BSP	1/4"	6976	90	9/16"
	1/4 BSP	5/16"	6977	120	5/8"
	3/8 BSP	3/8"	6978	130	3/4"
	1/2 BSP	1/2"	6979	150	7/8"